

multimes D6



19266_EDEBD0224-3724-1_EN

System | English



In our download centre you will find the appropriate instructions for KBR devices.

<https://www.kbr.de/en/download/operating-instructions/>

Table of Contents

1	Introduction	4
1.1	User manual	4
1.2	Intended use	4
1.3	Explanation of safety relevant symbols	5
1.4	Safety notes	6
1.5	Product liability	7
1.6	Disposal	7
<hr/>		
2	Device memory	8
<hr/>		
3	Definition of terms	9
<hr/>		
4	Field of application/ range of functions	10
<hr/>		
5	Connecting the multimes D6	12
5.1	Installation and assembly	12
5.2	Connection diagram	13
5.3	Terminal assignment	14
<hr/>		
6	Start-up	15
6.1	Control and display panel	15
6.2	LEDs	15
6.3	Default settings after reset	16
6.4	Basic device parameters	17

© KBR GmbH
Misprints and printing errors as well as
technical changes reserved.

1 Introduction

Thank you for choosing this KBR quality product.

To familiarize yourself with device operation and configuration, we recommend you read this manual carefully. This will enable you to make use of the entire range of functions that this high-quality product offers.

The individual chapters serve to explain the technical details of the device and show how to properly install and start up the device to prevent damage.

1.1 User manual

This user manual is included in the scope of delivery of the device and must be accessible to the user at all times (e.g. in the switchgear cabinet). Even if the device is resold to third parties, the manual remains an inherent part of the device.

Although the utmost of care has been taken in putting together this user manual, errors may still occur. We would be very grateful if you could notify us of any errors or unclear descriptions you may notice.

1.2 Intended use

This device helps you to optimize energy consumption and avoid expensive load peaks.

The system assists you in monitoring the energy consumption of your devices, helps you to make optimum use of your tariff and permanently lower your energy costs.

This device does not, however, render careful system planning indispensable. Moreover, it is essential that you take time to configure the device in line with your system parameters on first use and plan the shut-down of your devices.

1.3 Explanation of safety relevant symbols

These operating instructions contain notes that must be observed for your personal safety and to avoid damage to equipment. These notes are identified by a warning sign or information symbol, depending on the degree of hazard they represent.



Warning

"Warning" means that death, major injuries or damage may occur if the appropriate safety measures are not taken.



Caution

"Caution" means that minor injuries or damage may occur if suitable safety precautions are not taken.



Note

"Note" is an important piece of information on the product, its operation or the respective part of the operating instructions to which special reference is being made.

Disclaimer

The contents of these operating instructions have been carefully reviewed in terms of the hardware and software described. Nonetheless, deviations cannot be ruled out, and the manufacturer cannot guarantee 100% conformity. The specifications made in these operating instructions are reviewed on a regular basis; any corrections required will be included in the next revision.

1.4 Safety notes

In order to prevent operating errors, device operation is kept as simple as possible. This will enable you to start your device up quickly.

In your own interest, however, the following safety notes should be read carefully. The applicable DIN / VDE regulations must be observed for installation!

Power supply connection, setup and operation of the device must be performed by qualified personnel only. Qualified personnel as defined in the safety notes in this user manual are those authorized to set up, ground and mark devices, systems and circuits in accordance with applicable standards and regulations.

To prevent fire and electric shocks, the device must not be exposed to rain or humidity!

Before connecting the device to the power supply, check whether the local power supply conditions comply with the specifications on the device nameplate.



Caution

A faulty connection may result in the destruction of the device!

For device connection, the data given in the connection chart must be complied with (see "Connection chart") and there must be no voltage in the connection lines. When wiring, always ensure that all wiring material used is neither damaged nor defective and that the polarity is correct!

In order to ensure proper and safe product operation, it must be transported, stored, installed and assembled in accordance with the specifications, as well as carefully operated and maintained.

A visibly damaged device must generally be considered unfit for use and disconnected from the power supply!

Error detection, repair and maintenance work may only be carried out in our facilities or after contacting our service team. Opening the device unauthorized shall render your warranty null and void. Correct operation can no longer be guaranteed!

Opening the device may expose live parts. Capacitors in the device may still be under load, even if the device has been disconnected from all voltage sources. Open devices must not be operated!

Systems that are at risk from lightning strikes must feature lightning protection for all input and output lines.

1.5 Product liability

You have purchased a high-quality product. Only components of the highest quality and maximum reliability are used.

Each device is subject to long-term testing before it is delivered.

For details on product liability, please refer to our general terms and conditions for electronic equipment, which you can find at www.kbr.de.

The warranty on device properties applies only if the device has been operated in accordance with its intended use!

1.6 Disposal

Defective, outdated or disused devices must be properly disposed of.

If required, we are happy to dispose of the devices for you.

2 Device memory

Non-volatile long-term memory

The device is equipped with an internal, non-volatile memory in which long-term data is stored.

Buffered real-time clock (RTC)

After an uninterrupted charging time (device connected to the supply voltage) of approx. 8 hours, the buffer capacitor will have a sufficient charge to protect the internal clock from failure due to lack of operating voltage for approx. 14 days.



Note

If the buffer capacitor is discharged and there is no supply voltage, once the device has been switched on the time settings will be incorrect and must therefore be reset.

3 Definition of terms

Below, you will find brief explanations of the terminology used in this manual.

Root-mean-square value:

By definition the square of the average value of a periodic or pulsating value is referred to as the root-mean-square value. multimes D6 exclusively uses the RMS values of pure periodic values.

Instantaneous root-mean-square value:

The value determined by the multimes D6 during its measurement intervals.

Measurement interval:

During a measurement interval, the electrical quantity "Voltage" or "Current" of one phase is scanned. The resulting scanning spots are available for further calculations. This interval is mainly determined by the A/D conversion.

Measuring cycle:

The measuring cycle is the time the measuring device needs in order to measure all the values recorded by the device for all three phases.

Firmware:

The operating system software implemented in the multimes D6's microcontroller.

Load profile memory:

Saves the actual values of the measurement periods with timestamp.

Measurement period maximum value:

The measurement period containing the highest (maximum) value that occurred.

Active/reactive power periods:

Actual active or reactive power within a measurement period.

Measurement period:

The period of time used to determine the average power demand. Typical intervals: e.g. 15, 30, 60 minutes.

DIN rail

Top hat rail / mounting rail acc. to DIN EN 50022

4 Field of application/range of functions

multimes D6 is a compact, easy-to-use energy meter that records active as well as reactive energy (for consumption and recovery).

This energy counting device was designed in accordance with the standards DIN EN 61036 (IEC 1036), DIN EN 61268 (IEC 1268) and requirement specification 2.0 revision 12/97 by the German Electricity Association (VDEW).

Dual-tariff counter function (HT/LT)

Consumption during high tariff and low tariff times is saved separately. Switching from high to low tariff times and vice versa is either carried out by means of a digital signal to be applied externally, e.g. from the energy supplier, or via an internal clock. A display flashing on the front of the device indicates which tariff is active at the moment. When operated with the KBR Energy Bus, switching can also be carried out centrally via the Multimaster or computer.

Convenient operation and display

The LCD serves to either display the measured values directly or enter the respective parameters and configuration data. In addition, six LEDs serve to show the status and monitor the functions. Four buttons facilitate clearly structured navigation through the menus.

For 100 to 400 V networks

The multimes D6 can be applied in three-wire as well as four-wire networks. If the measuring value displays in the three-wire network are incorrect, a zero-point creator should be used. The unit can be implemented in 100 V as well as in 400 V networks for direct measurement. Using a transducer adaptor, up to 700 V can be connected to the meter. Higher voltages can only be connected via external voltage transformers, whereby primary and secondary voltage can be freely programmed. The measuring voltage inputs of the device measure directly, i.e. they are not metalically separated by a voltage transformer!

For energy supply networks with outer conductor connected to the earth potential, suitable control gear with electrical isolation (e.g. voltage transformer) must be used.

x/5A or x/1A freely programmable

The measuring inputs for current must always be fed via current transformers, while the transformer ratio is programmable. The primary current value as well as the secondary current value can be selected.

Programmable pulse output

Active energy or reactive energy proportional pulses can be output via a programmable output laid out as an S_0 interface. The pulse output type (in proportion to active or reactive energy

for consumption or recovery) as well as the pulse values (number of pulses per kWh or per kvarh) and the pulse length can be configured. These pulses can be processed by, for example, a master system for data acquisition or optimization, a maximum-demand monitor or a central process control.

Each pulse is visualized by a flashing LED.

Serial interface for connection to the KBR Energy Bus

In its default configuration, the multimes D6 has a serial interface (RS-485) for operation with the KBR eBus.

A large amount of information that cannot be shown on the display can be read from the device via the Energy Bus.

Thus the online measuring values of the individual power factors and the individual power as well as a large amount of data can be read from the long-term memory.

Extensive storage functions

In addition to its counting functions, the multimes D6 offers extensive memory functions:

- 4-quadrant load profile memory to record the cumulated active and reactive power
- Memory to record the daily energy values for 365 days
- Memory for the previous month's maximum measurement period
- Event memory (4096 entries), for logging actions of the meter such as mains failures, tariff switches, delete functions etc.

These memory functions are only available via the KBR eBus.

Synchronization

Synchronization as well as high/low tariff switching can be controlled centrally via the KBR eBus or via the internal clock.

Software (optional)

A number of software products that can be run on most Microsoft® Windows® operating systems is available for the convenient programming and storage of long-term data.

Separate power supply

The device requires a separate auxiliary voltage for operation (see nameplate). For questions on this device or on our software products please don't hesitate to contact us. We will be glad to assist you. Please see the cover sheet of this manual for your contact address.

5 Connecting the multimes D6

5.1 Installation and assembly

The housing of the multimes D6 has been designed for wall mounting on a 35 mm DIN rail. The module is assembled to the mounted DIN rail.



Caution

The control voltage as well as the applied measuring voltage of the device must be protected by means of a back-up fuse. When connecting the current transformers, the energy flow direction and the correct assignment to the voltage paths must be observed!

For the wiring of the pulse output, we recommend to exclusively use shielded twisted pair material to avoid disturbance (e.g. installation line I-Y(ST) Y 2x2x-0.8mm, whereas the shielding may only be connected on one side).

During installation, please also observe our notes on safety measures against overvoltage and lightning in the chapter "Protective measures" of this manual.



Note

You should take the following points into consideration when connecting the device to the three-phase network to be measured:

- Energy flow direction
- Assigning of measuring voltage input/current transformer input

Rotary field:

As soon as the multimes D6 is connected to the mains, it will automatically detect the rotary direction.

Current transformer connection:

Energy flow direction:

When mounting the transformers, observe the current flow or energy flow direction. If the current transformers are inserted the wrong way round, the current will have a negative sign for active power input. In this case, interchange the pins of the terminals k and l of the affected transformers.

Assigning measuring voltage input / current transformer input:

The current transformer on terminal 20/21 (k1/I1) must be arranged in the phase where the measuring voltage for terminal 10 (L1) is measured. The same applies to the other transformer and measuring voltage connections.



Caution

Before any interchanging, the current transformers must be shorted out.

5.2 Connection diagram







5.3 Terminal assignment

Terminals 1 (L) / 2 (N) and PE	<p>Power supply connection</p> <p>A control voltage is required to supply the device with power. The device can be operated with a voltage from 85 V to 265 V.</p>
Terminals 20 (k1) and 21 (l1) 22 (k2) and 23 (l2) 24 (k3) and 25 (l3)	<p>Current measuring inputs</p> <p>The measuring inputs for current must be connected via current transformers x/1A AC or x/5A AC.</p> <p>When connecting transformers, pay attention to the energy flow direction and the correct assignment of measuring voltage inputs to the current transformers.</p>
Terminals 10 (L1) 11 (L2) 12 (L3) 13 (N)	<p>Voltage measuring inputs</p> <p>Three phase voltage measurement in 4-wire alternating current networks. Direct measurement is possible in the following networks: 3 x 100V/57,7V AC; 3 x 400V/230V AC;</p> <p>For higher voltages, the unit needs to be connected via a voltage transformer.</p>
Terminals 92 (B) 91 (A) 90 (earth)	<p>Bus connection</p> <p>For device configuration and for communication at the KBR eBus</p>
Terminals 34 (+) and 35 (-)	<p>Pulse output</p> <p>Output of energy-proportional pulses via a digital contact (S_0 interface in accordance with DIN 43864). Paying attention to the correct polarity is important for this output. The output signals can be processed by a maximum demand monitor or a master central process control, for example.</p>
Terminals 36 (+) and 37 (-)	not in use
Terminals 38 (+) and 39 (-)	<p>Tariff input</p> <p>A floating contact, e.g. from the energy supplier for switching from high to low tariff, can be connected to this input.</p>

6 Start-up

6.1 Control and display panel

The multimes D6 features four key buttons, , ,  and , to reach the individual menus and submenus for programming the device. The 6-digit LCD serves to display the currently selected measured values. Six green LEDs indicate the significance of the measured data as well as different messages.

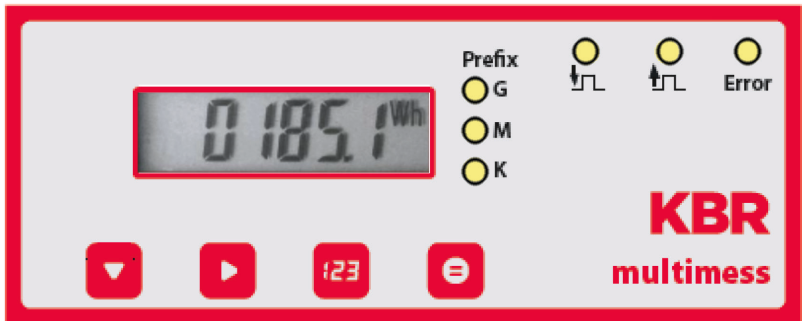

6.2 LEDs

LED "K" While the LCD shows the type of measurement and the measured numerical value, the three prefix LEDs "K," "M" and "G" show the significance of the unscaled unit. It is decisive which LED is active:

LED "M"

LED "G"

- "K" means that the value is shown in "kilo..." (e.g. [kW]),
- "M" stands for "mega..." (e.g. [MVAR]) and
- "G" corresponds to "giga..." (e.g. [GVA]);
- if no LED is active, the value is represented as an unscaled unit.

LED "Error" This LED flashes if an error message is waiting or an error has occurred.

LED  Not in use

LED  This LED always flashes when the pulse output is active.

6.3 Default settings after reset

Measuring voltage, primary	400 V
Measuring voltage, secondary	400 V
Measuring current primary	5 A
Measuring current secondary	5 A
Zero-point creator	Deactivated
Daylight saving time	from months 03 to 10
Frequency correction	automatic
Current average value over	10 minutes
Tariff switching	Bus
Default setting for internal tariff switching	Start time: 00:00 for LT start, End time: 00:00 for LT end
All measurements	Restart
Energy Memory	Deleting all energy memories
Measurement period	15 min.
Measurement period memory	Deleting all entries
Synchronization type	internal
Attenuation coefficient for current/voltage	0
Pulse output type	proportional to active energy, active energy consumption
Pulse value	1 pulse / kWh
Pulse length at pulse output	100 ms ($T_e/T_a = 50/50$)
Tariff	HT
Password	Default setting 9999, device can be freely configured

Unaffected by a RESET: Bus address and time

Basic configuration when delivered: All settings set to default values.

Bus address is 0000.

6.4 Basic device parameters

Parameters	Stored by user
Measuring voltage, primary	programmable by user from 1 to 99.99 kV
Measuring voltage, secondary	programmable by user from 1 to 600 V
Measuring current; transformer primary current	programmable by user from 0001 A to 9999 A
Measuring current (at device input, i.e. secondary transformer!)	can be selected by user: 1 A or 5 A
Pulse output type / pulse value	according to user settings - 0.00 to 9999 P/kWh
Pulse length	30 to 990 ms
Tariff switching	user can select digital input, switching via KBR eBus or at times programmed in the device
Synchronization settings	Setting options: Bus and internal clock
Bus mode	Choice of KBR eBus, Modbus RTU or Modbus ASCII
Bus address	according to user settings between 0001 and 9999 for KBR eBus and 1 to 247 for Modbus
Time	acc. to user settings in hh:mm:ss
Password	according to user settings, password is a 4-digit number (leading zeros); 9999 means: Device is not password-protected
Device name	any name chosen by the user 1*)
Event name	an individual designation is assigned to every event
Measurement period	1 / 15 / 30 / 60 min. 1*)

1*) This function can only be set using the computer, with optionally available software (e.g. visualenergy).

7 Measured values of the multimes D6 and their representation

The following section provides an overview of the measured values of the multimes D6 and their representation on the device. The respective measuring range is automatically switched over in the display.

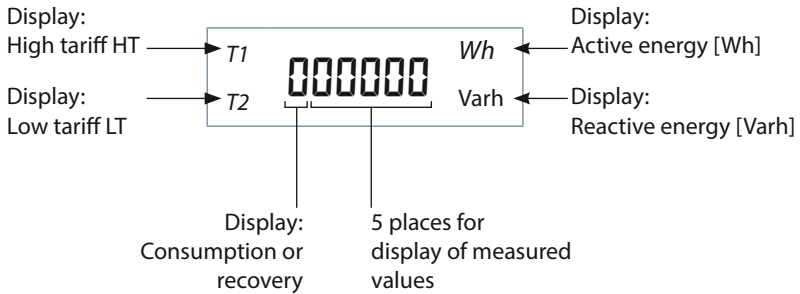

7.1 Display of active or reactive energy measurement

Example:
Display:

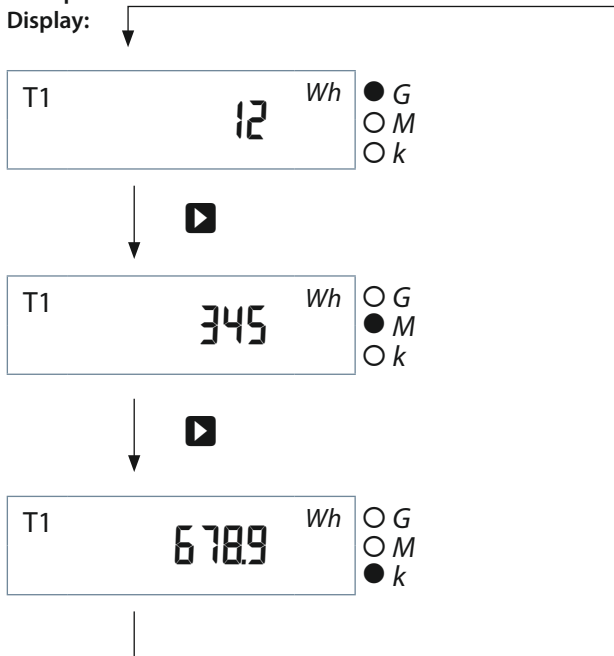

Display of the active energy W_{Act} in kWh, MWh or GWh and the reactive energy W_{React} in kVarh, MVarh or GVarh. The output measuring value must be calculated with the respective display significance "Kilo," "Mega" or "Giga," depending on the active LED.

7.2 Display of power measurement

The total active power measurement is identified by a „P“ in the first place, „S“ identifies the total apparent power measurement and „Q“ identifies the total reactive power measurement.

Active power during energy consumption is displayed without a polarity sign, during energy recovery with a negative polarity sign. For inductive reactive power, the measured value is preceded by an „L“; capacitive reactive power is identified by a „C“.

For the display of the measured values themselves the same principles apply as for the display of active and reactive energy. The output measuring value must be multiplied with the respective display significance „Kilo“, „Mega“ or „Giga“, depending on the active LED.

Display of active power in W, kW, MW, GW, the apparent power S in VA, kVA, MVA, GVA and the reactive power Q in Var, kvar, Mvar, Gvar.

7.2.1 Display for energy consumption or recovery

Whether energy is recovered can be determined by means of the polarity sign for the active power and the continuous counter.

7.2.2 Display of the power factor

If the power factor λ is measured, this is indicated by "PF" (power factor) in the first of the two spaces in the display.



By definition the power factor is the relationship of the active power to apparent power

$$\lambda_p = PF = \frac{P}{S}$$

In contrast to the $\cos \varphi$, for the power factor λ the proportion of distortion reactive power is included in the calculation.

Display of the **power factor** λ in the range 0.00 to 1.00.

8 Programming

The multimes D6 is programmed using the 4 keys , ,  and .

8.1 Working with the display menu

Pressing the navigation key  jumps to the respective following menu item.



Note

The active tariff is indicated by permanent flashing of the respective tariff display T1 or T2 in every display menu.



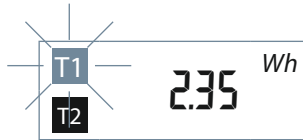



Active energy for low tariff



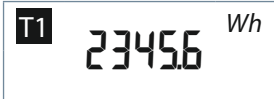





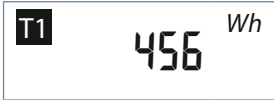



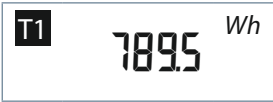









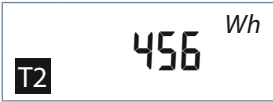











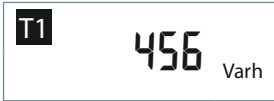

Display of the accumulated active energy in low tariff.

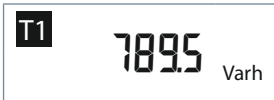
The tariff display T2 (low tariff) lights up permanently.

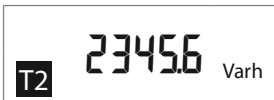
The tariff display T1 flashes, i.e. the current counting tariff is T1 (high tariff)

Menu	LCD	Unscaled unit
Active energy W_{Act} for high tariff		kWh if the prefix LED "k" lights up. (if the prefix LED "G" or "M" lights up, other menus are available)
Continue in the main menu  or 		For meter count detailed view
		Detailed view gigawatt-hours GWh if the prefix LED "G" is active
Continue with  or  to jump back to the basic menu		
		Detailed view megawatt-hours MWh if the prefix LED "M" is active







Menu	LCD	Unscaled unit
Continue with  or  to jump back to the basic menu		Detailed view kilowatt-hours kWh if the prefix LED "K" lights up
Back to main menu  or 		kWh if the prefix LED "k" lights up. (if the prefix LED "G" or "M" lights up, other menus are available)
Active energy W_{Act} for low tariff		
Continue in the main menu  or 		For meter count detailed view Detailed view gigawatt-hours GWh if the prefix LED "G" is active
Continue with  or  to jump back to the basic menu		Detailed view megawatt-hours MWh if the prefix LED "M" is active
Continue with  or  to jump back to the basic menu		Detailed view kilowatt-hours kWh if the prefix LED "K" lights up
Back to main menu  or 		kvarh if the prefix LED "k" lights up. (if the prefix LED "G" or "M" lights up, other menus are available)
Reactive energy W_{React} for high tariff		

Menu	LCD	Unscaled unit
Continue in the main menu  or 		For meter count detailed view
		Detailed view gigavar-hours Gvarh if the prefix LED "G" is active
Continue with  or  to jump back to the basic menu		
		Detailed view megavar-hours Mvarh if the prefix LED "M" is active
Continue with  or  to jump back to the basic menu		
		Detailed view kilovar-hours kvarh if the prefix LED "K" lights up
Back to main menu  or 		
Reactive energy W_{React} for low tariff		kvarh if the prefix LED "k" lights up. (if the prefix LED "G" or "M" lights up, other menus are available)
Continue in the main menu  or 		For meter count detailed view
		Detailed view gigavar-hours Gvarh if the prefix LED "G" is active
Continue with  or  to jump back to the basic menu		





Menu	LCD	Unscaled unit
		Detailed view megavar-hours Mvarh if the prefix LED "M" is active
Continue with or to jump back to the basic menu		
		Detailed view kilovar-hours kvarh if the prefix LED "K" lights up
Back to main menu or		
Voltage Ph-N L1		V if no prefix LED is active
Continue with to L2 and L3 or to the basic menu		
Voltage Ph-Ph L1-2		V if no prefix LED is active
Continue with to L2-3 and L3-1 or to the basic menu		
Current L1		A if no prefix LED is active
Continue with to L2 and L3 or to the basic menu		
Apparent power S_{total}		VA if no prefix LED is active
Active power P_{total}		W if no prefix LED is active

Menu	LCD	Unscaled unit
<input checked="" type="checkbox"/> <i>Reactive power Q_{total}</i>	9.7238 var	<i>var if no prefix LED is active</i>
<input checked="" type="checkbox"/> <i>Power factor λ</i>	PF 0.52	<i>Display of the power factor (fundamental component and harmonics)</i>
<input checked="" type="checkbox"/> <i>Device time</i>	12:34:55	<i>Output format Hours: Minutes: Seconds</i>
<input checked="" type="checkbox"/> <i>Devices - date</i>	12.04.15	<i>Output format Day: Month: Year</i>
<input checked="" type="checkbox"/> <i>Firmware Version</i>	5.00r.01	<i>Version number V5.00 Release 01</i>
<input checked="" type="checkbox"/> <i>Network frequency</i>	Fr 50.01	<i>measured power frequency</i>
<input checked="" type="checkbox"/> etc.		

8.2 Programming scheme

	Pressing both keys simultaneously will jump to the configuration menu from any other menu.
	Confirm inputs or changes. Changes can only be carried out after a valid password is entered or after the device has been unlocked (password 9999).
	Cancels input from any position in the configuration menu without applying values. Jumps back to point where input started. If input is not active, continue to next item.
	Changes to the input mode, i.e. the first place of the value to be modified flashes. Pressing the key again will jump to the second place of the value to be modified, etc.
	Pressing the key steps through the flashing value from 0 to 9.
	Confirms the inputs made. (Values are only saved to the device after the configuration menu is closed, i.e. after the last Config - menu item has been passed)

8.3 Working with the configuration menu

Menu	Key combination	Device display	Description
Configuration menu			Changes to the programming mode; display flashes
	Press both keys simultaneously  or 		Execute configuration menu or Cancel, i.e. back to display of measuring values



Note

The display will automatically jump back from the configuration menu to the display menu after 60 seconds of inactivity, without saving changes. If you want to change displayed settings, you will have to enter the appropriate password to get access.

The password is queried when you press the key.

No password is required to check the set parameters if no changes are to be made. You can scroll through the complete configuration menu while it is locked using the key.

Menu	Key combination	Device display	Description
Reset			Reset should only be carried out during setup and when the device is completely reprogrammed. <i>Caution! Reset will reset all programmed values back to default settings</i>
			Jump to the next menu without performing a reset
	or +		Key combination to carry out reset











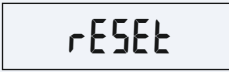

Note

Press the key and hold it down while also pressing the key.

The “Reset” display flashes for approx. 5 sec. (keep button pressed). The “Reset” is only carried out with a delay of these same 5 seconds, i.e. the reset procedure can be canceled by releasing the keys while the “Reset” display is still flashing.

The “Reboot” display will appear.

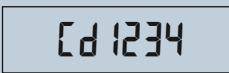
After this key combination has been pressed for more than 5 sec., the device is back in its default state; data and parameter memory are deleted.

Menu	Key combination	Device display	Description
Carry out reset	 + 		The display flashes for approx. 5 sec.; the reset function is carried out with a delay of these same 5 sec.
			Display appears briefly after reset has been performed, resetting the device to factory defaults
Enter password			
			Password is queried (only when password 9999 is not used) Password 9999 in original state or after reset => access to all inputs.
	 + 		Enter password
			



Note

If the password is entered correctly, changes can now be carried out within the configuration menu. When leaving the configuration menu, the password will become active again. If a wrong password is entered, the password is queried again if changes are to be applied.

Menu	Key combination	Device display	Description
Measuring voltage, primary			e.g.: Operation in a network with 400 V rated voltage (U_{PH-PH})
	+		Change measuring voltage to 500 V, for example



Note

If all 4 digits are flashing, you can add a decimal point with the button. The prefix LED "K" will then also light up next to the display.

Menu	Key combination	Device display	Description
Measuring voltage, secondary			e.g.: Operation in a network with 400 V rated voltage (U_{PH-PH})
	+		Change measuring voltage to 100 V, for example
Transformer – Primary current			Display of the configured primary current, e.g.: 5 A
	+		Programming transformer primary current, e.g.: 1500 A

Menu	Key combination	Device display	Description
Transformer secondary current			Display of the secondary current, in this case 5 A; 5 A or 1 A selectable
	 save with		Switching from 5 A to 1 A

Menu	Key combination	Device display	Description
Zero-point creator			Zero-point creator deactivated (default)
	 save with		Activate zero-point creator
Delete active energy memory			Menu to delete all energy memories













Note

Delete functions can only be carried out after the appropriate password has been entered.

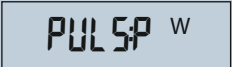
Procedure for delete functions:

- Press both keys simultaneously and hold.
- The display flashes for 5 sec. The "CLEAR" function is only carried out after this 5 second delay, i.e. the delete procedure can be canceled by releasing the keys while the display "CLEAR" is still flashing.
- When this key combination is kept depressed for more than 5 sec., all energy memories for HT as well as for LT are deleted irrevocably.
- After deleting, the "donE" display remains lit for a few seconds.

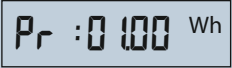
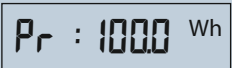
Menu	Key combination	Device display	Description
Carry out delete function	 +  press simultaneously and hold for > 5 sec.		The display flashes for 5 sec.; the delete function is carried out with a delay of these same 5 sec. Display after energy memory has been deleted
			
Pulse output: proportional to active or reactive energy on consumption or recovery	 +  save with 		Pulse output type kWh: in prop. to active or reactive energy W = in prop. to active energy Var = in prop. to reactive energy Programming the pulse output type for reactive energy: Display switches from W to Var
			
Pulse value of the output	 +  save with 		Pulse value 01.00 Pulses per kWh or kvarh 0000 = pulse output deactivated Programming the pulse value for the pulse output; e.g. 100.00 P/kWh
			

Menu	Key combination	Device display	Description
Pulse length of the output		PL: 100	Length of the energy pulse in ms, adjustable from 30–990 ms Default 100 ms
	▶ + 123 save with	PL: 080	Set length of the energy pulse e.g. to 80 ms
	⊖ ▼		
Tariff switching method		t2:d 16	Switching T1/T2 by floating contact
		t2:d 16	Change switching method: switching possibilities as follows: diG = signal on digital input buS = via Energy Bus command or Int = internally progr. Period
		t2:buS	
		t2:Int	
▶ + 123 save with			
	⊖ ▼		
Start low tariff time		tA:22:00	Start LT time: Default: 10:00
	▶ + 123 save with	tA:23:30	Change start of LT time: Enter time in hours: Minutes
	⊖ ▼		
End Low tariff time		tE:06:00	End LT time Default: 6:00
	▶ + 123 save with	tE:07:30	Change end of LT time: Enter time in hours: Minutes
	⊖ ▼		

Menu	Key combination	Device display	Description
Measurement period synchronization			Measurement period synchronization Default SY = int Synchronization is carried out by internal clock
	 save with 		Change synchronization type: SY-int; Internal synchronization or SY-buS; synchronization through energy bus command and internal clock
Bus mode			KBR eBus active Change Bus mode: The following switching possibilities:
	 save with 		eBus: KBR eBus or
			rtu: Modbus RTU or
		ASCII: Modbus ASCII	
Modbus mode (only if rtu or ASCII was selected in Bus mode)			9600 baud, no parity
	 save with 		Change transmission: Options:
			n 4.8, e 4.8, o 4.8, n 9.6, e 9.6, o 9.6 n 19.2, e 19.2, o 19.2

Menu	Key combination	Device display	Description
Bus address			Display of device address
		only eBus 	Starting the automat. bus scan (display flashes for approx. 60 sec.) As soon as the device is recognized at the bus, an address is assigned automatically by the PC software and the address is entered in the device memory
			With the key the automated process can be stopped and an address can be entered manually. Jump to the next menu without changing the device address
	+ save with 		Manual setting of device address (eBus 1–9999, Modbus 1–247)
Time			Time of internal clock Display does not change in configuration menu.
			Set device time Enter clock time in the format hh:mm:ss

19266_EDEBD A0224-3724-1_EN

Menu	Key combination	Device display	Description
Date			Date of internal clock
	 save with		Set date, enter date in format dd:mm:yy



Note

Setting the internal clock may have an influence on the load profile memory.

If the time of the multimes D6 is adjusted by less than the duration of one period, the measurement for the instantaneous period is finished at the next synchronization event and saved.

If the time of the multimes D6 is moved back by more than the duration of one period, the load profile memory is deleted and restarted. In both cases, a clock adjustment event is created and saved in the event memory.

Menu	Key combination	Device display	Description
Password			Current password is displayed if it has been entered elsewhere previously
			Otherwise: enter password
	 save with		Change password e.g. 4321
			Exit configuration menu, save values and apply. The display for the kWh meter count T1 (HT) is shown

8.4 Storage

8.4.1 Device settings

All device settings and configuration data for the memory function are stored in the device.



Note

The parameters cannot be changed by means of the software via the bus as long as a user is in the device configuration menu on location.

8.4.2 Long-term memory

The multimes D6 offers the user the long-term memory described in the following section.

8.4.2.1 Load profile memory

The meter has a load profile memory that is able to record the active energy for consumption and energy recovery as well as the reactive energy inductively and capacitively depending on the period duration set. The period duration can be set by the user via PC software to 60, 30, 15 or 1 minute; the number of entries is 3840.

This means that a period duration of 60 minutes results in a maximum storage duration of 160 days.



Note

Setting the internal clock:

If the time of the multimes D6 is adjusted by less than the duration of one period, the measurement for the instantaneous period is finished at the next synchronization event and saved.

If the time of the multimes D6 is moved back by more than the duration of one period, the load profile memory is deleted and restarted. In both cases, a clock adjustment event is created and saved in the event memory.

Adjusting the period duration:

If the period duration is adjusted, the load profile memory is deleted and restarted. An adjustment event (adjustment of the period duration) is created and entered in the event memory.

8.4.2.2 Annual energy memory

The daily energy values of the past 365 days for W_{Act} consumption, W_{Act} recovery, W_{React} inductive and W_{React} capacitive are stored in an annual energy memory separated for high and low tariff.

8.4.2.3 Event memory and operation logbook

There are 4096 events and operation logbook entries stored with date, time and status in a ring buffer.

The following events and entries are recorded:

Events	Recording
Event memory	Event memory deleted
Tariff input	Switchover signal HT => LT with date and time
	Switchover signal LT => HT with date and time
Sync input	Synchronization off the screen
External synchronization missing	via KBR eBus command
Real-time clock	incorrect time
Automatic voltage range switching	Measuring range switched
Automatic current range switching	Measuring range switched
Current path	Current path overloaded
Voltage path	Voltage path overloaded
Event memory	Event memory faulty
Flash memory	Flash error

Logbook entries	Recording
Reset	Reset performed
Event memory	Event memory deleted
Operation logbook	Operation logbook deleted
General operational event	Error type, date, time
Error state has been reset	current status deleted
Cycle memory	Cycle memory has been deleted
Daily energy memory	Daily energy memory has been deleted
Continuous energy memory	Continuous energy memory has been deleted
Parameter changes leading to deletions from memory	Voltage transformer ratio has been changed
	Current transformer ratio has been changed
Date and time changed	new time
Power failure	End time
Bus address changed	old address, new address
Controlled restart	Reboot
Firmware	Firmware updated
Watchdog	Restart Watchdog



Note

The described memories can only be read out via the KBR eBus by means of optionally available software.

8.4.3 Measurement period synchronization

Measurement period synchronization of the multimes D6 can be carried out in one of two ways, while the measurement period duration can be adjusted as described in the chapter "Device memory." The measurement period duration and the synchronization always affect all period values.

The following 2 types of synchronization are possible:

8.4.3.1 Synchronization only by internal clock.

Synchronization by internal clock is started with the initial reset. From this start time, the clock will synchronize the measurement period every 15 minutes (with respect to the full hour).

8.4.3.2 Synchronization by the KBR eBus

Synchronization is carried out via a telex created by the Busmaster and sent to the selected recipients via the KBR eBus.

9 Serial interface

9.1 Operating modes and interface configuration

9.1.1 RS 485 Bus operation

The device's RS-485 interface is designed for operation on the KBR eBus. You can operate one or several multimes D6 devices together with the Energy Bus across great distances (max. 1200 m without a multisys D2-ESES bus repeater). Using the relevant Windows® software, all bus devices can be configured and visualized. We will be glad to provide information on which other devices you can connect to the Energy Bus and on the functions of our Windows® software.

Information on the structure and technical parameters of the Energy Bus can be found in our installation guide for the KBR eBus. Just send a request for this installation guide.

9.1.2 Protective measures

Overvoltage and lightning protection:

It is recommended to install overvoltage protection measures to protect our high-quality devices from damage. We recommend protecting control voltage inputs and pulse lines if required.

10 Troubleshooting

No function:

Check power supply, backup fuse and supply line.

The measured values for power differ compared with the power supplier measurement:

Check k and l of the current measurement, the correctness of the phases of the transformers as well as the values entered for the transformer primary and secondary current and adjust, if required.

See "Operating the Configuration menu," menu item "Transformers – Primary current" and "Transformers – secondary current."



Note

Error call (LED Error flashes):

After pressing the  key, the error message is displayed.

The error message E-rnBE is displayed

Check the connected measuring voltage and the voltage transformer. This message appears if the rated voltage of 400 V is exceeded by at least 25%.

The error message E-PL S is shown

Check the pulse value with reference to the pulse duration.

Correct the pulse length or the pulse value, if required.

The maximum active or reactive energy that can be processed can be estimated by means of the following calculation

$$\frac{3600 \text{ s}}{2 \times IL \times IP / \text{kWh (kvarh)}} = \text{Maximum value}$$

Explanation:

3600 Constant [s]

IL Required pulse length [s]

IP/kWh(kvarh) Required pulse count per kWh or per kvarh [P/kWh or P/kvarh]

Maximum value Maximum active or reactive energy that can be output [kWh or kvarh]

After error recovery, acknowledge error message with the  key

The error message E-PRrR is displayed

If this text appears in the display, a parameter error occurred. Reset the device.



Note

Take notes of all programmed parameters as they will return to their default settings after the reset. After resetting, the multimes D6 must be programmed again.

The error message E-5Ync is displayed

Depending on the user configuration, synchronization could not be carried out via KBR eBus contact.

Acknowledge error message with the  key.

11 Technical data:

11.1 Measuring and display values

Active energy	Calculation	W_p
	Units	kWh if the prefix LED "K" is active MWh if the prefix LED "M" is active GWh if the prefix LED "G" is active
	Display range	0.0000 kWh to 9999 GWh; auto range switching
Reactive energy	Calculation	W_Q
	Units	kVArh if the prefix LED "K" is active MVarh if the prefix LED "M" is active GVArh if the prefix LED "G" is active
	Display range	0.0000 kVArh to 9999 GVArh; auto range switching
Active power	Calculation	$P_\Sigma / PL_1, PL_2, PL_3$; display of phase power only via Energy Bus
	Units	W if no prefix LED is active kW if the prefix LED "K" is active MW if the prefix LED "M" is active GW if the prefix LED "G" is active
	Display range	10.0 W to 9999 GW; auto range switching
Apparent power	Calculation	$S_\Sigma / SL1, SL2, SL3$; display of phase power only via Energy Bus
	Units	VA if no prefix LED is active kVA if the prefix LED "K" is active MVA if the prefix LED "M" is active GVA if the prefix LED "G" is active
	Display range	10.0 VA to 9999 GVA; auto range switching

Reactive power	Calculation	$Q_{\Sigma} / Q_{L1}, Q_{L2}, Q_{L3}$; display of the phase reactive power only via Energy Bus, distinction ind. /cap.
	Units	VAR if no prefix LED is active kVAR if the prefix LED "K" is active MVAR if the prefix LED "M" is active GVAR if the prefix LED "G" is active
	Display range	10.0 VAR to 9999 GVAR; auto range switching
Power factor	Power factor	$\lambda_{\Sigma} / \lambda_{L1}; \lambda_{L2}; \lambda_{L3}$ Display of the phase power factors only via Energy Bus The power factor contains the first and overharmonics
	Display range	0.00 → 1.00
Voltage	RMS value of a measurement interval	Phase - N; $U_{L1-N} / U_{L2-N} / U_{L3-N}$ Phase - Phase; $U_{L1-L2} / U_{L2-L3} / U_{L3-L1}$
	Units	V if no prefix LED is active KV if the prefix LED "K" is active MV if the prefix LED "M" is active GV if the prefix LED "G" is active
	Display range	0.0 V to 99.9 GV Ph-N; 0.0 V to 9.9 GV Ph-Ph; auto range switching
Current	RMS value of a measurement interval	$I_{L1Mom}; I_{L2Mom}; I_{L3Mom}$ Instantaneous value per phase
	Average value determination	$I_{L1Mit}; I_{L2Mit}; I_{L3Mit}$; floating average value from RMS values over 10 minutes
	Units	A if no prefix LED is active KA if the prefix LED "K" is active
	Display range	0.0 A to 99.9 GA auto range switching

11.2 Measuring accuracy

Voltage/current with respect to the rated value	$\pm 0.5\% \pm 1$ digit
Apparent power/active power with respect to the rated value	$\pm 1\% \pm 1$ digit
Reactive power with respect to the rated value	$\pm 2\% \pm 1$ digit
Frequency	± 0.1 Hz / ± 1 digit

11.3 Measuring principle

Reading	102 points per period
A/D converter	16 bit
Update time (display)	~ 500ms
Update speed (complete measuring cycle)	~ 200 ms
Frequency measurement	Mode: Voltage measured between phase L1, L2, or L3 and N
Frequency range	Automatic frequency correction between 45-65 Hz

11.4 Device memory

Data storage	1 MB flash non-volatile
Memory type	Ring buffer
Long-term memory (1 year)	Annual energy memory: Daily values for active and reactive energy, for high and low tariff, for consumption and recovery for one year
Long-term memory for max. 160 days, min. 64 hours, depending on memory configuration	Load profile memory: Maximum 3840 entries; 60 / 30 / 15 / 1 minutes. Period values for active and reactive energy, for consumption and energy recovery; period duration can be configured via operating software.
Event memory/operation logbook	A maximum of 4096 entries to record tariff switching commands, mains failures, error messages etc.
Parameter memory	non-volatile
Password memory	Code: 4 digits, numerical

19266_EDEBD0224-3724-1_EN

11.5 Power supply

Power supply	85 to 265 V AC/DC; 50/60 Hz
Power consumption	< 15 VA

11.6 Operating and display elements

Operation	4 sensor buttons
Measuring values	8-digit 7-segment LCD
Control display	6 green LEDs: 3 x display significance, 1 x error message, 1 x digital input (not in use), 1 x pulse output

11.7 Hardware inputs

Voltage measuring inputs	UL1-L2; UL2-L3; UL3-L1	3 * 5 V...100 V...120 V AC (measuring range 1) 3 * 30 V...400 V...480 V AC (measuring range 2)
	Input impedance	1.8 MOHM (Ph-Ph)
	Measuring range	programmable
Current measuring inputs	IL1; IL2; IL3	3 * 0.01 A...1 A...1.2 A AC (measuring range 1) 3 * 0.05 A...5 A...6 A AC (measuring range 2)
	Power consumption	≤ 0.3 VA per input at 6 A
	Measuring range	programmable
2 digital inputs	Input 1 No function	Measurement period synchronization internal only or via KBR eBus
	Tariff input	Digital input for floating contact, switching HT/LT, signal e.g. from energy supplier, contact open => tariff HT, contact closed => tariff LT
	S ₀ compatible	< 2 mA = off; > 10 mA = on
	Output voltage	<24 V DC: Observe polarity
	Output current	< 15 mA DC

11.8 Hardware outputs

Pulse output	Output type	In proportion to active or reactive energy; programmable on the device
	Optocoupler output	max. 15 mA; S ₀ compatible according to DIN 43865
	Pulse value	Linear: programmable from 0.00 to 9999 P/kWh or P/kVArh limited additionally by the max. possible pulse frequency of 16 Hz
	Pulse length	default 100 ms; 30–990 ms configurable on the device
	Interpulse period	= Pulse length
	External voltage supply	max. 35V / 30 mA DC; ensure correct polarity
Serial interface	BUS	RS485 for connection to the KBR eBus or Modbus; a max. of 32 devices per bus segment, up to 1000 m without a bus repeater; for additional information see installation guide
	Baud rate	KBR eBus 38400 Baud Modbus: RTU or ASCII; Baud rate 4800, 9600, 19200; parity none, even, odd
	Addressing	KBR eBus: Can be addressed up to address 9999; via software or manually on the device Modbus: Address 1 to 247

11.9 Electrical connection

Connection elements		Screw terminals
Max. permissible connection line cross-section		2.5 mm ²
Measurement voltage inputs	Fuse protection	F2-F4: Recommended: 0.1 A < fuse < 4 A
Measuring current inputs	Fuse protection	NONE!!! Always short-circuit current transformer terminals k and l prior to opening the circuit!
Input Power supply	Fuse protection	F1: Recommendation 1 AT < fuse < 4 AT
BUS - Connection	Connection material	For proper operation please only use shielded twisted-pair cables; e.g. I-Y(St)Y EIB 2x2x0.8
Pulse output	Connection and cables	Ensure proper polarity! For proper operation, use shielded twisted-pair cables only, e.g. I-Y(St)Y 2x2x0.8
Tariff input	Connection and cables	Ensure proper polarity! For proper operation, use shielded twisted-pair cables only, e.g. I-Y(St)Y 2x2x0.8
Transformer connection	Connections	see connection chart
Interface connection	Pins for BUS connection via RS-485	Terminal 90 ⊥ Terminal 91 A Terminal 92 B

11.10 Mechanical data

Top hat rail device	Housing dimensions	90 x 106.4 x 61 mm (H x W x D),
	Mounting type	Wall mounting on DIN rail 7.5 mm deep, in accordance with DIN EN 50022, suitable for distribution board mounting
	Weight	Approx. 650 g

11.11 Dimensioned drawing

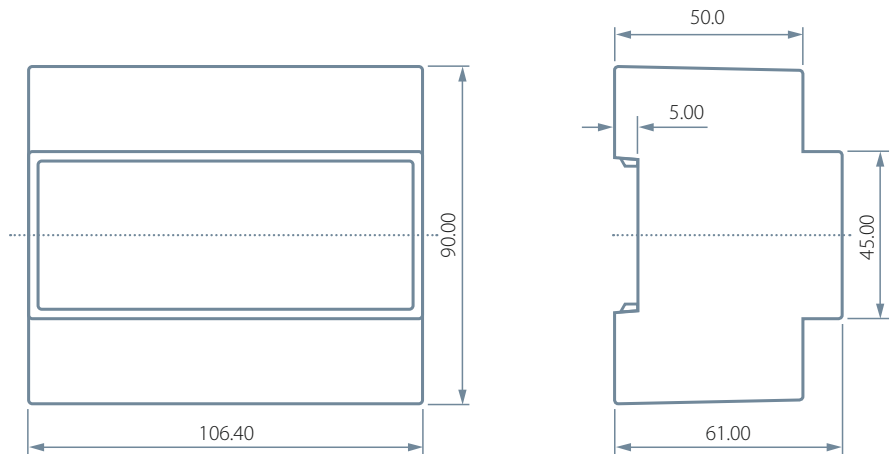

11.12 Ambient conditions, electrical safety and standards

Ambient conditions	Standards	DIN EN 60721-3-3:1995-09 + DIN EN 60721-3-3/A2:1997-07; 3K5+3Z11; (IEC721-3-3;3K5+3Z11)
	Operating temperature	-5°C to +55°C
	Humidity	5% to 95% non-condensing
	Storage temperature	-25°C to +70°C
	Operating altitude	0 to 2000 m above sea level
Electrical safety	Standards	DIN EN 61010-1:2011-07; DIN EN 61010-2-030:2011-07
	Protection class	I
	Overvoltage category, measurement category	III
Protection type	Standards	DIN EN 60529:2014-09
	Front	IP 51
	Terminals	IP 20
EMC	Standards	DIN EN 61000-6-2:2006-03 + Amendment 1:2011-03 DIN EN 61000-6-3:2011-09 + Amendment 1:2012-11



A series of 20 horizontal lines spaced evenly down the page, providing a template for handwritten notes.

19266_EDEBDA0224-3724-1_EN





A series of 20 horizontal lines spaced evenly down the page, providing a template for handwritten notes.



KBR GmbH

Am Kieferschlag 7
D-91126 Schwabach,
Germany

P +49 (0) 9122 6373-0
F +49 (0) 9122 6373-83
E info@kbr.de

www.kbr.de